

## AA®720 Inward Opening Window Systems

### Introduction

The AA®720 Series has been developed to meet the latest European requirements for thermal performance and has been future proofed against expected changes in thermal regulation up to 2019.

To enable complete flexibility of design, performance and cost, the AA®720 Series is available in four levels of thermal performance – the AA®720, the AA®720 HW, the AA®720 HI and the AA®720 HI Reflex.

The 72mm profiles incorporate the very latest thermal technology including; extruded polyamide and patented thermal breaks, insulated centre seals, foam isolators and foam core insulation.

As well as being fully integrated, the range can suite with Kawneer's curtain walling and framing products and is suitable for installation in low or high rise buildings for commercial and domestic new build or refurbishment projects.

### Construction

Crimped or pinned with mechanical corner cleats. Corner braces are also used.

Weathering is achieved by the use of single and dual durometer, EPDM gaskets.

Pressure equalised system.

### Configurations

As well as flexibility in performance, the AA®720 offers versatility in design with the range encompassing a wide variety of integrated window and door configurations. There is also a fire resistant AA®720 FR variant within the range that provides fire-rated door and fixed screen solutions.

Design variants to the AA®720 inward opening window range are:

- Softline/Design variants with rounded contours
- Renovation "TIP" steel window replacement system
- Renovation variant with angular contours
- Concealed Vent variant where vent profiles are not visible from the outside
- Curtain Wall Look-alike variant that offers the appearance of curtain wall

For information on Kawneer's AA®720 Series Door Systems please refer to the Door Systems brochure.

### Glazing

Glazing and panels up to 56mm thickness can be accommodated enabling the use of triple glazing for when there is a requirement for the very highest thermal and acoustic performance.

### Security\*

The AA®720 Tiltturn Window has been independently tested to PAS 24:2016.

*\* Does not refer to standard hardware, security hardware required.*



## Independently Weather Performance Tested to BS 6375-1: 2015

	Air Infiltration BS EN 12207: 2000	Watertightness BS EN 12208: 2000	Wind Resistance BS EN 12210: 2000
AA®720 Tiltturn	Class 4 (600 Pa)	Class E1200 (1200 Pa)	Class E2400 (2400 Pa)

All Windows comply with Operation and Strength Test BS 6375 Pt2: 2015

Details of the Kawneer product tests are available from the Technical Services Department at Runcorn.

## Thermal Performance - Inward Opening

### AA®720 HI Reflex Tiltturn

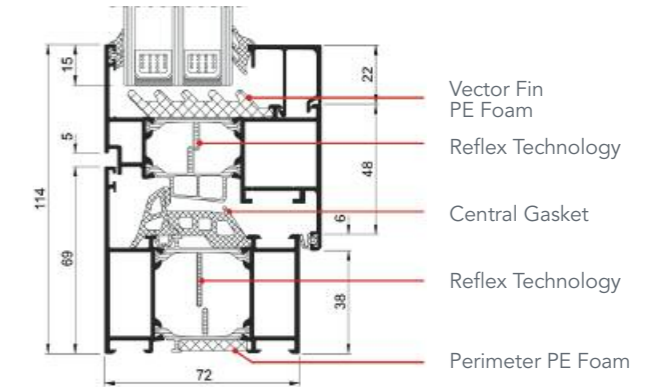
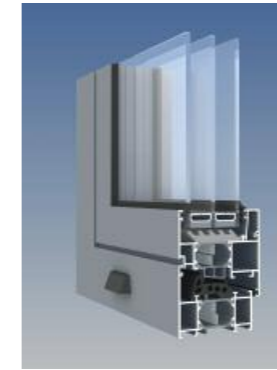

### AA®720 HI Tiltturn

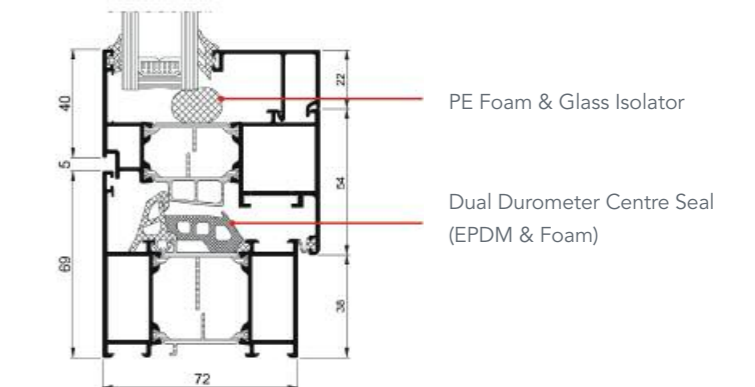
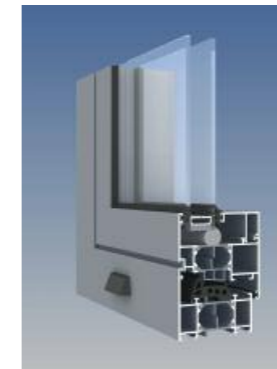

### AA®720 HW Tiltturn

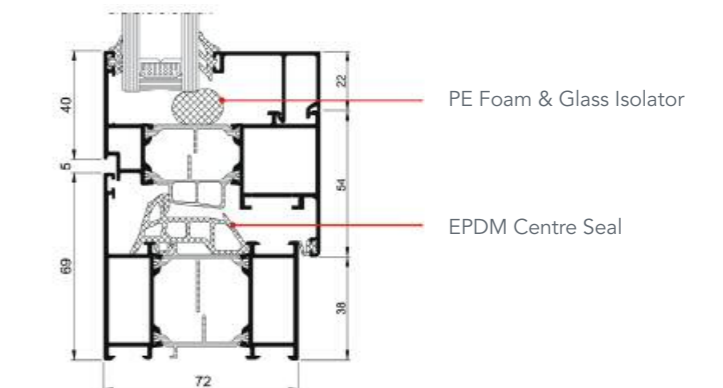
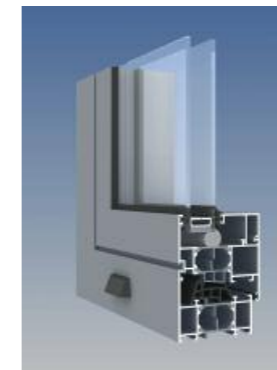

### AA®720 Tiltturn

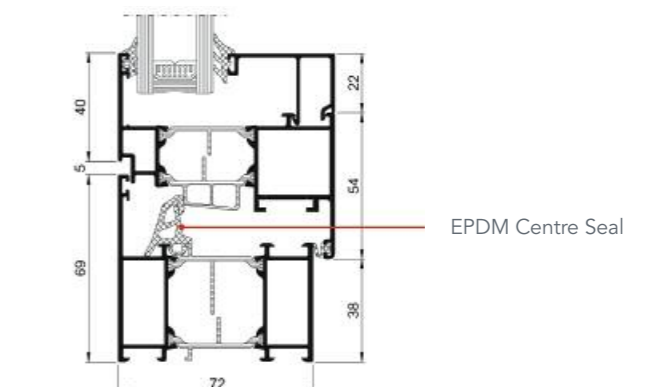
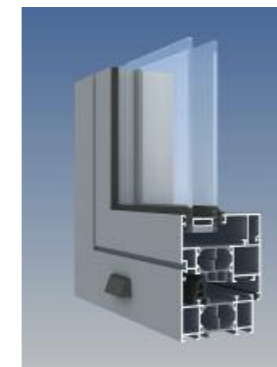

### The AA®720 Reflex Technology

Due to the anticipated amendments to Approved Document L, and the continued market demands for high performance windows, Kawneer has developed a unique system it can apply to its polyamide thermal breaks to give further thermal improvements to the window, and reduce heat transfer through the profile.

The inclusion of a low emmissivity reflective foil to the thermal 'flags' allows the AA®720 Tiltturn to achieve U-values as low as 1.0 W/m²K for a CEN size window with a warm edge spacer\*\*

### Additional Product Features

In addition to the features described, the AA®720 Tiltturn Window offers market leading weight capabilities for a top hung window. With a capability of up to 130kg, high performance acoustic and/or security glass applications can be easily accommodated within the standard window without additional reinforcements or fabrication requirements.

With a choice of locking or non locking handles in a range of finishes, the system can be incorporated effectively in a number of applications.

The AA®720 Tiltturn Window has been designed with flexibility and ease of fabrication as key requirements. The system is internally glazed and incorporates a standard hardware groove, to provide cost effective locking hardware without compromising performance or security.

### Thermal Performance

The AA®720 Tiltturn can be manufactured within 4 levels of thermal performance – providing flexibility in design, performance and cost.

AA®720 – Most cost effective option – EPDM centre seal.

AA®720 HW – Greater Performance Level, cost conscious – Closed cell vent perimeter foam, EPDM centre seal.

AA®720 HI – Greater Performance Level – Closed cell vent perimeter foam, dual durometer centre seal.

AA®720 HI Reflex – Highest Performance Level – Reflex Technology within the vent and frame profiles, closed cell PE vector fin glazing rebate foam, closed cell frame perimeter foam insulation tape, dual durometer centre seal.

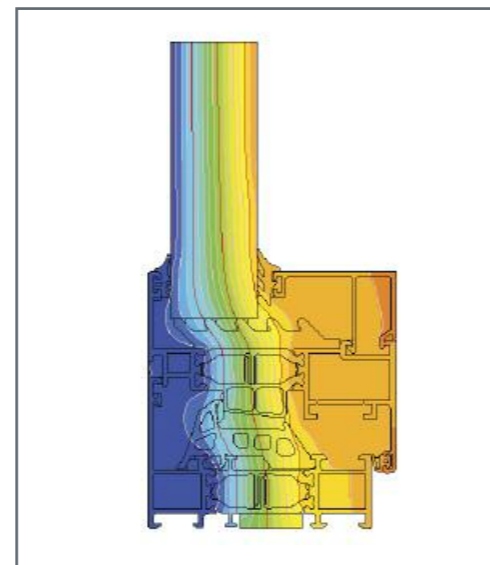

Thermal Evaluation of the AA®720 HI Reflex Tiltturn Window

	Tiltturn		HW Tiltturn		HI Tiltturn		HI Reflex Tiltturn	
Glass	1.0 Ug*	0.6 Ug**	1.0 Ug*	0.6 Ug**	1.0 Ug*	0.6 Ug**	1.0 Ug*	0.6 Ug**
Overall Uw	1.5 W/m²K	1.2 W/m²K	1.3 W/m²K	1.0 W/m²K	1.3 W/m²K	1.0 W/m²K	1.3 W/m²K	1.0 W/m²K

Based on a 34mm Outer Frame/43mm Inside Glaze vent Combination

\* Window Energy Ratings and U-values based on CEN size windows (1230mm x 1480mm) using 1.0 W/m²K double glazing with warm edge (0.048 W/m²K) spacer.

\*\* U-values based on CEN size windows (1230mm x 1480mm) using 0.6 W/m²K triple glazing with warm edge (0.043 W/m²K) spacer.

## AA®720 Inward Opening Windows

### AA®720 HI Standard

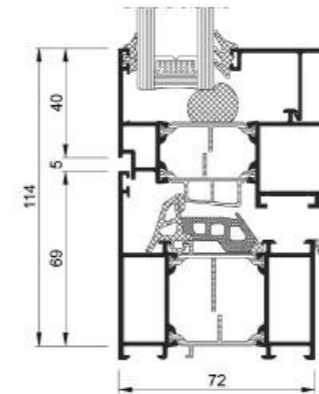

Straight overall contour with flush vent and frame line

### AA®720 HI Softline

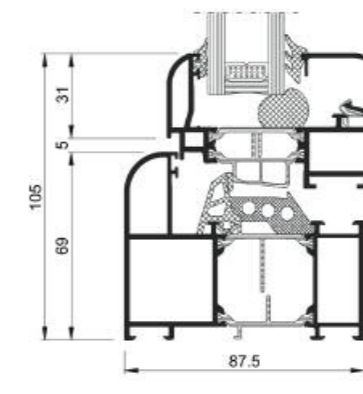

Rounded overall contour

### AA®720 HI Integral (Concealed Vent)

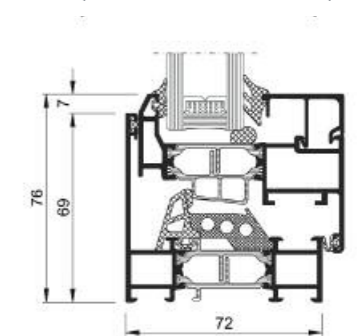

Narrow sightlines with visible aluminium facet on the vent

### AA®720 HI Renovation

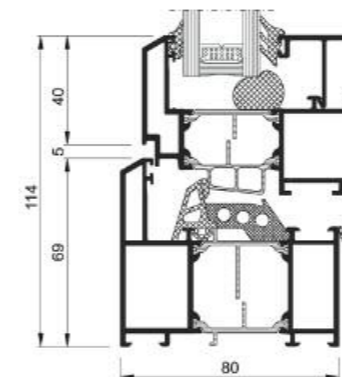

Angular contours for renovation projects

### AA®720 HI Renovation "TIP"

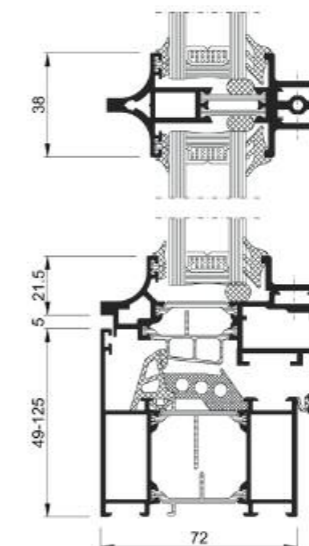

For the replacement of steel heritage windows

### AA®720 HI Curtain Wall Look-alike

